

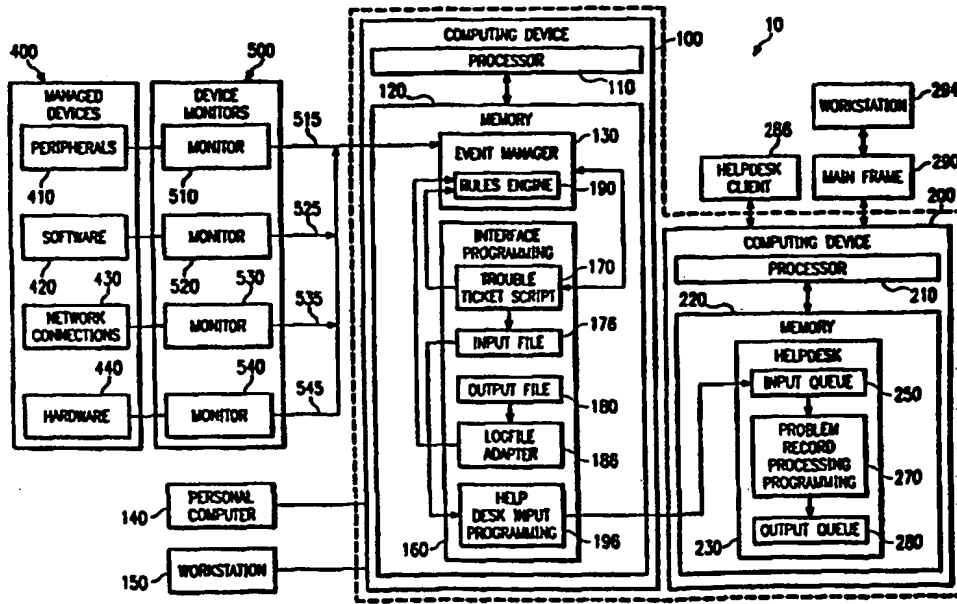

INTERNATIONAL APPLICATION PUBLISHED UNDER THE PATENT COOPERATION TREATY (PCT)

<p>(51) International Patent Classification ⁶ : G06F 9/00</p>	<p>A2</p>	<p>(11) International Publication Number: WO 98/52121 (43) International Publication Date: 19 November 1998 (19.11.98)</p>
<p>(21) International Application Number: PCT/US98/09837 (22) International Filing Date: 13 May 1998 (13.05.98) (30) Priority Data: 08/855,081 13 May 1997 (13.05.97) US (71) Applicant: ELECTRONIC DATA SYSTEMS CORPORATION [US/US]; 5400 Legacy Drive, M/S H3-3A-05, Plano, TX 75024 (US). (72) Inventors: TOPFF, Guido, E., J.; Putrand 4, B-2288 Grobendonk (BE). KOUWENBERG, Frederik, P., J.; Loevestein 38, NL-2804 EV Gouda (NL). (74) Agent: GRIEBENOW, L., Joy; Electronic Data Systems Corporation, 5400 Legacy Drive, H3-3A-05, Plano, TX 75024 (US).</p>		<p>(81) Designated States: European patent (AT, BE, CH, CY, DE, DK, ES, FI, FR, GB, GR, IE, IT, LU, MC, NL, PT, SE). Published <i>Without international search report and to be republished upon receipt of that report.</i></p>

(54) Title: METHOD AND SYSTEM FOR MANAGING COMPUTER SYSTEMS



(57) Abstract

According to one aspect of the invention, a method of managing a computer system includes receiving event information at a Tivoli Enterprise Console (130), the event information associated with the computer system. The method also includes receiving a command to provide a portion of the event information to a help desk application program and automatically providing the event information in a format readable by a ServiceCenter help desk application program (230) in response to receiving a command to provide a portion of the event information to a help desk application program.

FOR THE PURPOSES OF INFORMATION ONLY

Codes used to identify States party to the PCT on the front pages of pamphlets publishing international applications under the PCT.

AL	Albania	ES	Spain	LS	Lesotho	SI	Slovenia
AM	Armenia	FI	Finland	LT	Lithuania	SK	Slovakia
AT	Austria	FR	France	LU	Luxembourg	SN	Senegal
AU	Australia	GA	Gabon	LV	Larvia	SZ	Swaziland
AZ	Azerbaijan	GB	United Kingdom	MC	Monaco	TD	Chad
BA	Bosnia and Herzegovina	GE	Georgia	MD	Republic of Moldova	TG	Togo
BB	Barbados	GH	Ghana	MG	Madagascar	TJ	Tajikistan
BE	Belgium	GN	Guinea	MK	The former Yugoslav Republic of Macedonia	TM	Turkmenistan
BF	Burkina Faso	GR	Greece	ML	Mali	TR	Turkey
BG	Bulgaria	HU	Hungary	MN	Mongolia	TT	Trinidad and Tobago
BJ	Benin	IE	Ireland	MR	Mauritania	UA	Ukraine
BR	Brazil	IL	Israel	MW	Malawi	UG	Uganda
BY	Belarus	IS	Iceland	MX	Mexico	US	United States of America
CA	Canada	IT	Italy	NE	Niger	UZ	Uzbekistan
CF	Central African Republic	JP	Japan	NL	Netherlands	VN	Viet Nam
CG	Congo	KE	Kenya	NO	Norway	YU	Yugoslavia
CH	Switzerland	KG	Kyrgyzstan	NZ	New Zealand	ZW	Zimbabwe
CI	Côte d'Ivoire	KP	Democratic People's Republic of Korea	PL	Poland		
CM	Cameroon	KR	Republic of Korea	PT	Portugal		
CN	China	KZ	Kazakstan	RO	Romania		
CU	Cuba	LC	Saint Lucia	RU	Russian Federation		
CZ	Czech Republic	LI	Liechtenstein	SD	Sudan		
DE	Germany	LK	Sri Lanka	SE	Sweden		
DK	Denmark	LR	Liberia	SG	Singapore		
EE	Estonia						



INTERNATIONAL APPLICATION PUBLISHED UNDER THE PATENT COOPERATION TREATY (PCT)

<p>(51) International Patent Classification ⁶ : H04L 12/24, G06F 11/32</p>	<p>A3</p>	<p>(11) International Publication Number: WO 98/52121 (43) International Publication Date: 19 November 1998 (19.11.98)</p>
<p>(21) International Application Number: PCT/US98/09837 (22) International Filing Date: 13 May 1998 (13.05.98) (30) Priority Data: 08/855,081 13 May 1997 (13.05.97) US (71) Applicant: ELECTRONIC DATA SYSTEMS CORPORATION [US/US]; 5400 Legacy Drive, M/S H3-3A-05, Plano, TX 75024 (US). (72) Inventors: TOPFF, Guido, E., J.; Putrand 4, B-2288 Grobendonk (BE). KOUWENBERG, Frederik, P., J.; Loevestein 38, NL-2804 EV Gouda (NL). (74) Agent: GRIEBENOW, L., Joy; Electronic Data Systems Corporation, 5400 Legacy Drive, H3-3A-05, Plano, TX 75024 (US).</p>		<p>(81) Designated States: European patent (AT, BE, CH, CY, DE, DK, ES, FI, FR, GB, GR, IE, IT, LU, MC, NL, PT, SE). Published <i>With international search report.</i> (88) Date of publication of the international search report: 18 February 1999 (18.02.99)</p>

(54) Title: METHOD AND SYSTEM FOR MANAGING COMPUTER SYSTEMS

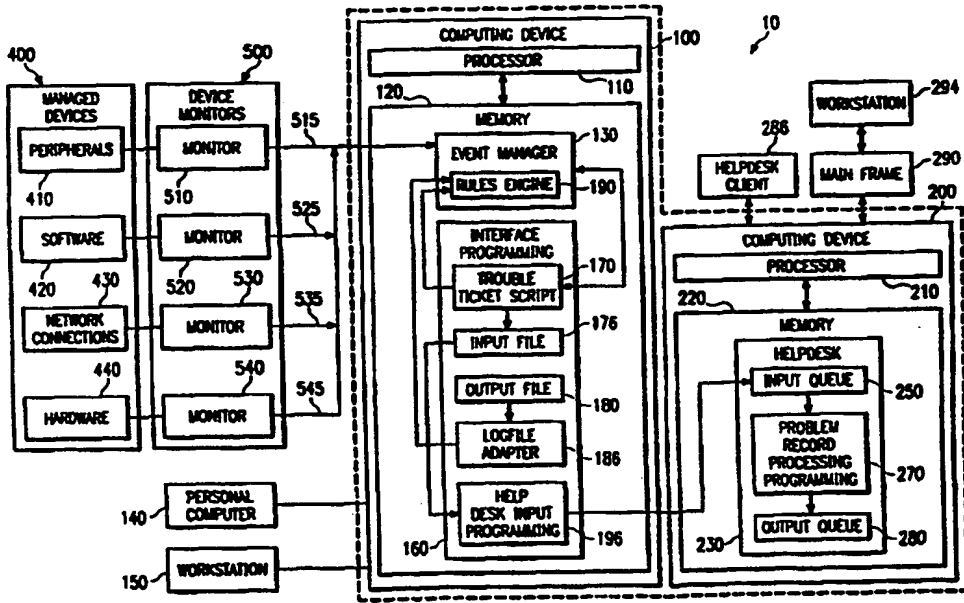

(57) Abstract

According to one aspect of the invention, a method of managing a computer system includes receiving event information at a Tivoli Enterprise Console (130), the event information associated with the computer system. The method also includes receiving a command to provide a portion of the event information to a help desk application program and automatically providing the event information in a format readable by a ServiceCenter help desk application program (230) in response to receiving a command to provide a portion of the event information to a help desk application program.

FOR THE PURPOSES OF INFORMATION ONLY

Codes used to identify States party to the PCT on the front pages of pamphlets publishing international applications under the PCT.

AL	Albania	ES	Spain	LS	Lesotho	SI	Slovenia
AM	Armenia	FI	Finland	LT	Lithuania	SK	Slovakia
AT	Austria	FR	France	LU	Luxembourg	SN	Senegal
AU	Australia	GA	Gabon	LV	Latvia	SZ	Swaziland
AZ	Azerbaijan	GB	United Kingdom	MC	Monaco	TD	Chad
BA	Bosnia and Herzegovina	GE	Georgia	MD	Republic of Moldova	TG	Togo
BB	Barbados	GH	Ghana	MG	Madagascar	TJ	Tajikistan
BE	Belgium	GN	Guinea	MK	The former Yugoslav Republic of Macedonia	TM	Turkmenistan
BF	Burkina Faso	GR	Greece			TR	Turkey
BG	Bulgaria	HU	Hungary	ML	Mali	TT	Trinidad and Tobago
BJ	Benin	IE	Ireland	MN	Mongolia	UA	Ukraine
BR	Brazil	IL	Israel	MR	Mauritania	UG	Uganda
BY	Belarus	IS	Iceland	MW	Malawi	US	United States of America
CA	Canada	IT	Italy	MX	Mexico	UZ	Uzbekistan
CF	Central African Republic	JP	Japan	NE	Niger	VN	Viet Nam
CG	Congo	KE	Kenya	NL	Netherlands	YU	Yugoslavia
CH	Switzerland	KG	Kyrgyzstan	NO	Norway	ZW	Zimbabwe
CI	Côte d'Ivoire	KP	Democratic People's Republic of Korea	NZ	New Zealand		
CM	Cameroon			PL	Poland		
CN	China	KR	Republic of Korea	PT	Portugal		
CU	Cuba	KZ	Kazakistan	RO	Romania		
CZ	Czech Republic	LC	Saint Lucia	RU	Russian Federation		
DE	Germany	LI	Liechtenstein	SD	Sudan		
DK	Denmark	LK	Sri Lanka	SE	Sweden		
EE	Estonia	LR	Liberia	SG	Singapore		

Patent document cited in search report		Publication date	Patent family member(s)	Publication date
EP 0295426	A	21-12-1988	US 4823345	A 18-04-1989
			CA 1328682	A 19-04-1994
			DE 3889149	D 26-05-1994
			DE 3889149	T 17-11-1994
			JP 1010754	A 13-01-1989
			JP 1923140	C 25-04-1995
			JP 6024377	B 30-03-1994
WO 9631035	A	03-10-1996	US 5777549	A 07-07-1998
			US 5696486	A 09-12-1997
			AU 5325896	A 16-10-1996
			EP 0818096	A 14-01-1998

THIS PAGE BLANK (USPTO)

BEST AVAILABLE COPY

PCT/US 98/09837

A. CLASSIFICATION OF SUBJECT MATTER IPC 6 H04L12/24 G06F11/32				
According to International Patent Classification (IPC) or to both national classification and IPC				
B. FIELDS SEARCHED				
Minimum documentation searched (classification system followed by classification symbols) IPC 6 H04L G06F				
Documentation searched other than minimum documentation to the extent that such documents are included in the fields searched				
Electronic data base consulted during the international search (name of data base and, where practical, search terms used)				
C. DOCUMENTS CONSIDERED TO BE RELEVANT				
Category	Citation of document, with indication, where appropriate, of the relevant passages	Relevant to claim No.		
A	EP 0 295 426 A (IBM) 21 December 1988 see abstract see column 1, line 1-20 see column 4, line 10 - column 6, line 50 see figure 1B ---	1, 9, 14		
A	JANDER M: "MANAGEMENT FRAMEWORKS MOVING TOWARD A UNIFIED VIEW OF DISTRIBUTED NETWORKS" DATA COMMUNICATIONS, vol. 23, no. 3, 1 February 1994, pages 58-66, 68, XP000422746 see page 58, left-hand column, paragraph 1 - right-hand column, paragraph 2 see page 59, right-hand column, paragraph 5 - page 62, left-hand column, paragraph 2 see page 64, left-hand column, paragraph 2 - page 68, middle column, paragraph 5 --- -/--	1, 9, 14		
<input checked="" type="checkbox"/> Further documents are listed in the continuation of box C.				
<input checked="" type="checkbox"/> Patent family members are listed in annex.				
* Special categories of cited documents :				
<table style="width:100%; border: none;"> <tr> <td style="width:50%; border: none; vertical-align: top;"> "A" document defining the general state of the art which is not considered to be of particular relevance "E" earlier document but published on or after the international filing date "L" document which may throw doubts on priority claim(s) or which is cited to establish the publication date of another citation or other special reason (as specified) "O" document referring to an oral disclosure, use, exhibition or other means "P" document published prior to the international filing date but later than the priority date claimed </td> <td style="width:50%; border: none; vertical-align: top;"> "T" later document published after the international filing date or priority date and not in conflict with the application but cited to understand the principle or theory underlying the invention "X" document of particular relevance; the claimed invention cannot be considered novel or cannot be considered to involve an inventive step when the document is taken alone "Y" document of particular relevance; the claimed invention cannot be considered to involve an inventive step when the document is combined with one or more other such documents, such combination being obvious to a person skilled in the art. "&" document member of the same patent family </td> </tr> </table>			"A" document defining the general state of the art which is not considered to be of particular relevance "E" earlier document but published on or after the international filing date "L" document which may throw doubts on priority claim(s) or which is cited to establish the publication date of another citation or other special reason (as specified) "O" document referring to an oral disclosure, use, exhibition or other means "P" document published prior to the international filing date but later than the priority date claimed	"T" later document published after the international filing date or priority date and not in conflict with the application but cited to understand the principle or theory underlying the invention "X" document of particular relevance; the claimed invention cannot be considered novel or cannot be considered to involve an inventive step when the document is taken alone "Y" document of particular relevance; the claimed invention cannot be considered to involve an inventive step when the document is combined with one or more other such documents, such combination being obvious to a person skilled in the art. "&" document member of the same patent family
"A" document defining the general state of the art which is not considered to be of particular relevance "E" earlier document but published on or after the international filing date "L" document which may throw doubts on priority claim(s) or which is cited to establish the publication date of another citation or other special reason (as specified) "O" document referring to an oral disclosure, use, exhibition or other means "P" document published prior to the international filing date but later than the priority date claimed	"T" later document published after the international filing date or priority date and not in conflict with the application but cited to understand the principle or theory underlying the invention "X" document of particular relevance; the claimed invention cannot be considered novel or cannot be considered to involve an inventive step when the document is taken alone "Y" document of particular relevance; the claimed invention cannot be considered to involve an inventive step when the document is combined with one or more other such documents, such combination being obvious to a person skilled in the art. "&" document member of the same patent family			
Date of the actual completion of the international search	Date of mailing of the international search report			
28 October 1998	04/11/1998			
Name and mailing address of the ISA European Patent Office, P.B. 5818 Patentlaan 2 NL - 2280 HV Rijswijk Tel. (+31-70) 340-2040, Tx. 31 651 epo nl, Fax: (+31-70) 340-3016	Authorized officer Lievens, K			

INTERNATIONAL SEARCH REPORT

International Application No
PCT/US 98/09837

C.(Continuation) DOCUMENTS CONSIDERED TO BE RELEVANT

Category	Citation of document, with indication, where appropriate, of the relevant passages	Relevant to claim No.
A	WO 96 31035 A (CABLETRON SYSTEMS INC) 3 October 1996 see abstract see page 1, line 13 - page 3, line 7 see page 5, line 20 - page 6, line 13 see figure 2 -----	1,9,14

Information on patent family members

PCT/US 98/09837

Patent document cited in search report	Publication date	Patent family member(s)	Publication date
EP 0295426 A	21-12-1988	US 4823345 A	18-04-1989
		CA 1328682 A	19-04-1994
		DE 3889149 D	26-05-1994
		DE 3889149 T	17-11-1994
		JP 1010754 A	13-01-1989
		JP 1923140 C	25-04-1995
		JP 6024377 B	30-03-1994
WO 9631035 A	03-10-1996	US 5777549 A	07-07-1998
		US 5696486 A	09-12-1997
		AU 5325896 A	16-10-1996
		EP 0818096 A	14-01-1998

THIS PAGE BLANK (USPTO)

METHOD AND SYSTEM FOR
MANAGING COMPUTER SYSTEMS

TECHNICAL FIELD OF THE INVENTION

This invention relates generally to the field of computer systems management and more particularly to a method and system for managing computer systems.

5

BACKGROUND OF THE INVENTION

Computer systems have become pervasive in today's society. Although computer systems may provide many advantages that make work easier, computer systems often require maintenance. To assist in maintaining a computer system, infrastructure management tools are often employed. In some infrastructure management tools, an important aspect of infrastructure management is monitoring. Monitoring tools may try to detect errors in computer systems before they turn into problems and to react to possible problems before a customer experiences a problem and calls a help desk associated with the computer system.

10

15

In one monitoring system, an event may be generated for each monitored item that does not conform to established criteria. An event describes the specifics of the affected device, the reason for non-conformance, and additionally provides control information, such as severity, class, or the time that the problem was detected. The event information may be consolidated within an event manager. The event manager handles the display functions

20

25

and processing of the events. One example of an event manager is the Tivoli Enterprise Console, available from Tivoli Systems of Austin, Texas.

5 The Tivoli Enterprise Console may handle all event processing for monitored devices and may present that information to monitoring operators. Conventionally, the monitoring operators assess all incoming events, investigate the possible causes, and apply proper correction procedures if necessary. If the monitoring operators decide that further escalation is necessary for an event or that other support groups need to be involved for solving the problem, then a help desk system may require the event information.

15 Help desk systems manage assignment of tasks related to solving various problems that may be experienced by a computer system. One example of a help desk system is ServiceCenter, available from Peregrine Systems, Inc. Although the Tivoli Enterprise Console and the ServiceCenter help desk each provide improvements to system management, the independent use of each of these creates several disadvantages. For example, events generated by the Tivoli Enterprise Console that require further assignment and escalation conventionally must be entered into the ServiceCenter help desk system manually. This procedure may retard or deter the overall problem solving process. In addition, in order to provide status tracking, an event identification number needs to be stored in each system. However, manual input of such an identification number may cause a considerable amount of overhead.

20
25
30 Moreover, synchronization between the two management tools, which is desirable to provide the same problem information

and event information to each management tool, cannot be readily achieved through separate use of each management tool because such synchronization may require help desk operators to have access to both management tools.

5 Finally, manual integration of these two management tools could introduce typographical errors.

SUMMARY OF THE INVENTION

Therefore, a need has arisen for a new method and apparatus that addresses the disadvantages and deficiencies of the prior art. The invention comprises a method and system for managing a computer system.

According to one aspect of the invention, a method of managing a computer system includes receiving event information at a Tivoli Enterprise Console, the event information associated with the computer system. The method also includes receiving a command to provide a portion of the event information to a help desk application program and automatically providing the event information in a format readable by a ServiceCenter help desk application program in response to receiving a command to provide a portion of the event information to a help desk application program.

According to another embodiment of the invention, a management system for managing a monitored device in a computer system includes a computing system having at least one processor and at least one memory accessible by the at least one processor. The management system also includes a Tivoli Enterprise Console event management system stored in the computing system. The event management system is operable to receive and process an event having event information. The event is associated with the monitored devices. The management system also includes a ServiceCenter help desk application program stored in the computing system. The ServiceCenter help desk application program is operable to process a problem record. The management system also includes interface programming stored on the computing system that operable to provide the

event information associated with the event to the help desk application program in a format readable by the help desk application program.

The invention provides numerous technical advantages.

5 For example, the invention automatically provides information associated with an event received by an event manager to a help desk application, thus alleviating any delay associated with manual entry of this information and preventing errors associated with manual entry of this
10 information. Furthermore, the status of the problem solution process, which is conventionally available to the help desk application, is automatically provided to the event manager. Thus the current status of the problem solving process can be known by operators of both
15 management systems, rather than solely known by operators of the help desk application.

Moreover, any overhead associated with manually providing the problem solving status to the event manager is avoided. In addition, a problem identification number
20 associated with the problem solving by the help desk application is automatically provided to the event manager, allowing status tracking without additional cost associated with manual entry of such an identification number.

BRIEF DESCRIPTION OF THE DRAWINGS

For a more complete understanding of the present invention and the advantages thereof, reference is now made to the following descriptions taken in connection with the accompanying drawings in which:

FIGURE 1 is a block diagram of one embodiment of a systems management system according to the teachings of the present invention;

FIGURE 2A is a flow chart illustrating exemplary steps associated with exchanging information between an event manager application program and a help desk application program according to the present invention;

FIGURE 2B is a flow chart illustrating exemplary steps of a portion of the flow chart illustrated in FIGURE 2A, showing additional details associated with automatic generation of a trouble ticket and opening and processing of a problem record;

FIGURE 2C is a flow chart illustrating exemplary steps of a portion of the flow chart shown in FIGURE 2C, illustrating steps associated with monitoring processing of a problem record; and

FIGURE 2D is a flow chart illustrating exemplary steps of a portion of the flow chart shown in FIGURE 2B, illustrating steps associated with executing a trouble ticket script.

DETAILED DESCRIPTION OF THE INVENTION

An embodiment of the present invention and its advantages are best understood by referring to FIGURE 1 and FIGURES 2A through 2D of the drawings, like numerals being used for like and corresponding parts of the various drawings. FIGURE 1 is a block diagram of one embodiment of a systems management system 10 according to the teachings of the present invention. Systems management system 10 allows for support of computer systems or devices by automatically providing information exchange between an event manager application program and a help desk application program.

Systems management system 10 preferably includes computing devices 100 and 200; however, computing devices 100 and 200 may be replaced with any suitable number of computing devices, including a sole computing device. Systems management system 10 receives signals from device monitors 500. Device monitors 500 monitor managed devices 400.

Managed devices 400 may include a variety of types of devices for which monitoring is desired. Exemplary types of devices suitable for management by systems management system 10 include peripherals 410, software 420, network connections 430, and other types of hardware 440. Non-conformance of managed device 400 with established criteria causes an event (not explicitly shown) to be generated.

Device monitors 500 are illustrated in block diagram form in FIGURE 1 and may include a variety of different types of monitors, depending on the type of managed device. Device monitors 500 are shown as including device monitors 510, 520, 530, and 540; however, any suitable number of

device monitors may be employed. Device monitors 510, 520, 530, and 540 produce event signals 515, 525, 535, and 545. Event signals 515, 525, 535, and 545 include event information associated with an event generated due to non-conformance of a managed device 400 with established criteria.

Event information may include, for example, details of the non-conforming managed device, the reason for non-conformance, control information such as problem severity, class of the problem, and the time the non-conformance was detected, and other suitable information. This event information received from device monitors 510, 520, 530, and 540 is consolidated within an event manager application program. An event manager application program handles display of event information to a monitoring operator and processing of event information. One example of an event manager application program is an event manager application program 130, which is illustrated in FIGURE 1 and described in greater detail below.

Computing device 100 preferably includes a processor 110 and a memory 120. Processor 110 may be operable to execute and access information stored in memory 120. Memory 120 may include storage devices, such as disk drives or other suitable methods for storing data, as well as random access memory. In one embodiment, computing device 100 utilizes a UNIX operating system; however, any suitable type of computing device running on any suitable operating system may be used. Memory 120 stores event manager application program 130. In one embodiment, event manager application program 130 is a Tivoli Enterprise Console, produced by Tivoli Systems of Austin, Texas.

Event manager application program 130 is operable to process each of event signals 515, 525, 535, and 545 from device monitors 500 and to present the event information associated with each of event signals 515, 525, 535 and 545 to monitoring operators (not explicitly shown) for assessment. These monitoring operators may investigate the possible causes of non-conformance and apply proper correction procedures if necessary. If a monitoring operator decides that further attention to an event is necessary or that other support groups need to be involved to address the event, event information contained in event signals 515, 525, 535, or 545 is automatically transmitted from event manager application program 130 to a help desk application program. The help desk application program controls the overall problem management process.

Event information contained in event signals 515, 525, 535, or 545 may be automatically transmitted upon command by a monitoring operator. An example of a monitoring operator commanding the automatic transmission of event information contained in event signals 515, 525, 535, or 545 is a monitoring operator requesting the generation of a trouble ticket by clicking an option button in a menu bar of a computer display associated with event manager application program 130. In response to clicking an option button in a menu bar, as discussed in greater detail below, a Unix shell script is launched. The Unix shell script initiates the automatic transfer of event information contained in event signals 515, 525, 535, or 545. In another embodiment, event information contained in event signals 515, 525, 535, or 545 is also automatically sent to a help desk application program, but a command from a

BEST AVAILABLE COPY

monitoring operator is not utilized. Rather, event manager application program 130 detects certain predetermined conditions associated with an event and, based on detecting certain predetermined conditions, automatically transmits
5 the event information contained in event signals 515, 525, 535, or 545.

Event manager application program 130 is accessible to users through a number of suitable techniques. For example, a personal computer 140 running appropriate software or a
10 workstation 150 may be used to access event manager application program 130.

Computing device 200 preferably includes a processor 210 and a memory 220 accessible by processor 210. In one embodiment, computing device 200 utilizes a UNIX operating
15 system; however, computing device 200 may use any suitable operating system. Stored in memory 220 is a help desk application program 230. In one embodiment, help desk application program 230 is a ServiceCenter application program, available from Peregrine Systems Inc. Help desk
20 application program 230 includes an input queue 250, a problem record processing programming 270, and an output queue 280. Each of these portions of help desk application program 230 is discussed in greater detail below. Help desk application program 230 may also contain additional
25 programming.

Help desk application program 230 is accessible through a variety of techniques. For example, a help desk client 286, which is, for example, a dedicated personal computer or workstation directly connected to computing
30 device 200 may be used to access help desk application program 230. Alternatively, for example, help desk

application program 230 may also be accessed through a workstation 294 connected to a mainframe computer 290, which is in turn directly connected to computing device 200.

5 According to the teachings of the invention, help desk application program 230 receives event information received by event manager application program 130, opens a problem record (not explicitly shown), processes the problem record, and returns status information associated with the
10 problem record for eventual receipt by event manager application program 130.

 Interface programming 160 may be stored in memory 120, as illustrated in FIGURE 1. Alternatively, interface programming 160 may be stored in any suitable location,
15 such as within memory 220, or within memory located in another computing device. Interface programming 160 facilitates automatic communication of information between event manager application program 130 and help desk application program 230.

20 Portions of memory 120 are preferably accessible, not only by processor 110, but also by processor 210. Thus, execution of either event manager application program 130 by processor 110 or help desk application program 230 by processor 210 can alter portions of an input file 176 and
25 an output file 180. Although computing devices 100 and 200 are shown as separate computing devices, each containing a separate processor and memory, these two separate computing devices 100, 200 may be replaced with a single computing device.

30 In one embodiment, interface programming 160 receives event information from event manager application program

130, interprets this event information, and provides this event information in an understandable format to help desk application program 230 for processing. In response to receiving this event information, help desk application program 230 generates a problem record associated with the event and processes the problem record. A problem record may contain information relating to an event, documentation relating to efforts to resolve non-conformance associated with an event, the status of efforts to resolve the non-conformance, and other additional information that is useful in resolving computer systems problems. In addition, interface programming 160 receives information relating to the processing of a problem record by help desk application program 230, such as status information. This received information is then interpreted by interface programming 160 and provided to event manager application program 130 in a form understandable by event manager application program 130.

Interface programming 160 may include a trouble ticket script 170. In one embodiment, trouble ticket script 170 is a UNIX Korn shell script; however, any suitable executable file or program may be used. Trouble ticket script 170 may be executed in response to receiving a command from a monitoring operator or, alternatively, automatically executed based on the content of event information received by event manager application program 130. Event information received by event manager application program 130 is available to trouble ticket script 170 through environment variables set by event manager application program 130. Execution of trouble ticket script 170 initiates automatic transfer of event

information from event manager application program 130 to help desk application program 230.

In addition to other functions discussed in greater detail below, trouble ticket script 170 modifies input file 176 contained within interface programming 160. Once modified, input file 176 includes information received by trouble ticket script 170 from event manager application program 130 that is formatted for reception by help desk application program 230.

Interface programming 160, may also include output file 180. Output file 180 stores information containing, for example, the status of a problem record generated by help desk application program 230 in response to the transmission of event information from event manager application program 130 to help desk application program 230.

Interface programming 160 may also include a logfile adapter 186. Logfile adapter 186 monitors output file 180 for added text. Additions to output file 180 may include, for example, status information associated with an event. If a new line is written to output file 180, logfile adapter 186 sends the information contained in the new line to a rules engine 190.

Rules engine 190 is also interface programming, but may be contained within event manager application program 130. Rules engine 190 includes interface programming that cooperates with interface programming 160 to provide status information received from help desk application program 230 to the event manager application program 130 in a format understandable by help desk application program 230.

Interface programming 160 may also include help desk input programming 196. Help desk input programming 196 monitors input file 176 for added text. Text is added to input file 176 through execution of trouble ticket script 170. If text is added to input file 176, help desk input programming 196 sends the added text to input queue 250 of help desk application program 230 for subsequent processing by problem record processing programming 270. During processing and after processing is completed, information relating to, for example, the status of the processing is sent to output queue 280 for subsequent transmittal to output file 180. Thus, according to the invention, information may be automatically exchanged between an event manager application program and a help desk application program.

With reference to FIGURE 1 and FIGURES 2A through 2D, operation of systems management system 10 is described. FIGURE 2A is a flow chart illustrating exemplary steps associated with the method of the invention, including detecting an event, automatically generating a trouble ticket associated with the event, opening a problem record, processing the problem record, and notifying event manager application program 130 of the status of processing of the problem record.

The method of the invention begins with the step 610 of monitoring for events. Device monitors 500 provide information to event manager application program 130. If an event is detected at step 612, event manager application program 130 receives event information from device monitors 500 describing details of the event, the reason for any non-conformance to preset criteria, and additional control

information, such as severity of the problem, class of the problem, and the time of the problem. This event information is consolidated, correlated, and presented to a monitoring operator at step 613 by event manager application program 130 to determine if action by a help desk, such as help desk application program 230, is desirable. If a monitoring operator determines that action by help desk application program 230 is desirable, a trouble ticket command, requesting automatic generation of a trouble ticket, is generated. Alternatively, event manager application 130 may automatically determine that action by help desk application program 230 is desirable based on the contents of the event information and initiate a trouble ticket command.

If action is desirable, a trouble ticket command is received at step 614. If automatic generation of a trouble ticket is commanded, at step 700 a trouble ticket is automatically generated and a problem record is opened and processed. The step 700 of automatically generating a trouble ticket and opening and processing a problem record is described in greater detail below in conjunction with FIGURE 2B. A purpose of automatically generating a trouble ticket is to automatically provide information associated with an event to help desk application program 230 in a format understandable by help desk application program 230. The generated trouble ticket, which is stored in input file 176, contains information required by help desk application program 230 to open a problem record for processing and is also in a format understandable by help desk application program 230. A purpose of opening and processing a problem record is to determine the cause of the non-conformance

associated with the event associated with the problem record and to remedy the non-conformance.

At step 1000, problem record processing that occurs at step 700 is monitored. Exemplary steps associated with step 1000 of monitoring processing of a problem record are illustrated in FIGURE 2C. A purpose of monitoring processing of a problem record is to keep event manager application program 130 current as to the status of the problem solving associated with the non-conformance that generated the event. When processing of a problem record is concluded, the status of the event associated with the processed problem record is changed to "CLOSED" at step 1100, and the system continues to monitor for additional events. In one embodiment of the invention, an event can have three possible statuses: "OPEN," "CLOSED," and "ACKNOWLEDGED." An event has a status of "OPEN" when it is received by event manager application program 130. An event has a status of "CLOSED" when it has been closed. An event has a status of "ACKNOWLEDGED" after it has been acknowledged by an operator.

Thus, according to the invention, event information is automatically provided from event manager application program 130 to help desk application program 230 in a format understandable by help desk application program 230. Conversely, according to the invention, status information concerning processing of a problem record associated with an event is provided from help desk application program 230 to event manager application program 130 in a format understandable by event manager application program 130. This exchange of information facilitates the problem

solving process and eliminates errors associated with manual entry of the above-described information.

5 Details of step 700 of automatically generating a trouble ticket and opening and processing a problem record are discussed in conjunction with FIGURE 2B. Step 700 accomplishes automatic transfer of event information from event manager application program 130 to help desk application program 230 in a format understandable by help desk application program 230.

10 FIGURE 2B is a flow chart illustrating exemplary steps of step 700 of the flow chart illustrated in FIGURE 2A, showing additional details associated with automatically generating a trouble ticket associated with an event received by event manager application program 130 and opening and processing a problem record based on the automatically generated trouble ticket. A first step 800 includes executing trouble ticket script 170. Exemplary steps associated with step 800 of executing trouble ticket script 170 are illustrated in FIGURE 2D. As discussed in greater detail below, execution of trouble ticket script 170 appends to input file 176 event information associated with the event for which automatic generation of a trouble ticket was requested. This information is appended to input file 176 in a format consistent with the format of a trouble ticket conventionally used with a ServiceCenter help desk application. In one embodiment, event information associated with an event for which automatic generation of a trouble ticket is requested is available to trouble ticket script 170 as environment variables in Unix. These environment variables are listed below in Table 1, which is an example listing of trouble ticket script 170.

Input file 176 is monitored at step 710 by help desk input programming 196 for any changes to input file 176. If a change in input file 176 is detected at step 720, information appended to input file 176 by trouble ticket script 170 is sent to event input queue 250 of help desk application program 230. Sending information appended to input file 176 to event input queue 250 may be accomplished by execution of help desk input programming 240 at step 730.

One example of suitable help desk input programming 240 is the "AXFILED" programming associated with the AXCES application program available from Peregrine Systems, Inc. In such an embodiment, information is read from input file 176 and sent to an input queue 250 for subsequent processing by problem record processing programming 270 as illustrated at step 740. In that embodiment, problem record processing programming 270 includes problem record processing programming available as part of the ServiceCenter help desk. Once input queue 250 receives this event information, a program record associated with the non-conforming event is opened and processed. Problem record processing programming 270 manages processing of a problem record. For example, problem record processing programming 270 may reassign a problem record, update a problem record, escalate a problem record, or otherwise operate to manage processing of a problem record. Problem record processing programming 270 appends information relating to the status of the problem record to output file 180 at step 750. In performing this step, the information may first be stored in output queue 280 before transfer to output file 180. Examples of information appended to

SUBSTITUTE SHEET (RULE 26)

output file 180 include information identifying that a problem record has been opened or closed and an associated problem record identification number.

5 Thus, according to the invention, event information is automatically provided from event manager application program 130 to help desk application program 230 in a format understandable by help desk application program 230.

10 Details of step 1000 of monitoring processing of a problem record are discussed in conjunction with FIGURE 2C. Step 1000 accomplishes transfer of status information concerning processing of a problem record from help desk application program 230 to event manager application program 130 in a format understandable by event manager application program 130.

15 FIGURE 2C is a flow chart illustrating exemplary steps of step 1000 of the flow chart illustrated in FIGURE 2A, illustrating steps associated with monitoring processing of a problem record. The step 1000 of monitoring processing of a problem record begins with step 1010 of monitoring
20 output file 180 for changes. Logfile adapter 186 may perform this monitoring function. As illustrated in FIGURE 2B, help desk application program 230 appends information regarding opening and closing of problem records to output file 180. In performing this step, the information may
25 first be stored in output queue 280 before transfer to output file 180. If a change is detected in output file 180 at step 1020, step 1025 of providing to rules engine 190 the information in output file 180 regarding opening and closing of problem records is executed by logfile
30 adapter 186. This information may include, for example,

information that a problem record has been open or closed or a problem number associated with an open problem record.

Logfile adapter 186 has an associated format file for use in interpreting information in output file 180. An example format file is provided below in Table 1.

Table 1: Example Logfile Adapter Format File

```

FORMAT SC_Callnumber FOLLOWS Logfile_Base
tivpmo,%s+,%s:" OPEN %s %s %s %s "
10 hostname "ns1 dsmc1"
msg PRINTF("OPENED Service Center Call: %s", sc_callnumber)
sc_callnumber $6
ev_event_handle $3
ev_server_handle $4
15 ev_date_reception $5
-msg_catalog $2
adapter_host "ns1 dsmc2"
END

20 FORMAT SC_Close_Event FOLLOWS Logfile_Base
tivpmc,%s+,%s:"CLOSED %s %s %s %s"
hostname "ns1 dsmc1"
date $1
msg PRINTF("CLOSED Service Center Call: %s", sc_callnumber)
25 ev_server_handle $4
ev_event_handle $3
ev_date_reception $5
sc_callnumber $6
-msg_catalog $2
30 adapter_host "ns1 dsmc2"
END
Copyright © 1997 by Electronic Data Systems, Inc.

```

In conjunction with the format file, logfile adapter 186 interprets information associated with a problem received and provides that information to rules engine 190 in a format understandable by rules engine 190. At step 1030, rules engine 190 parses this information, or in other words, scans this information for recognizable strings, and at step 1040 makes the information available for use by

event manager application program 130 in a format understandable by event manager application program 130 in order to update the status of an event or to provide the event with a problem record number associated with an open problem record.

5

For the embodiment in which event manager application program 130 is a Tivoli Enterprise Console, incoming messages into event manager application program 130 should be defined in advance as a particular message class that describes the structure and format of the incoming message. To facilitate definition of incoming messages from help desk application program 230 to event manager application program 130, the following Tivoli classes are defined: SC_Event, SC_Troubleshooting, SC_Callnumber, and SC_Close_Event. Definition of these classes may be as illustrated below in Table 2, in which the SC_Troubleshooting, SC_Callnumber, and SC_Close_Event classes are each a type of the SC_Event class, and SC_Event is a type of an Event class, defined by the ServiceCenter application program available from Peregrine Systems, Inc.

10

15

20

Table 2: Definition of Tivoli Classes

TEC_CLASS:

25

SC_EVENT ISA EVENT

DEFINES {

source: default + "SC";
sc_server_handle: INTEGER;
ev_server_handle: INTEGER;
ev_date_reception: INT32;
ev_event_handle: INTEGER;
};

30

END

35

```

TEC_CLASS:
    SC_Troubleshoot ISA SC_EVENT
    DEFINES {
5      };
END

```

```

TEC_CLASS:
    SC_Callnumber ISA SC_EVENT
10     DEFINES {
      };
END

```

```

15     TEC_CLASS
        SC_Close_Event ISA SC_EVENT
        DEFINES {
          };
END

```

20 Copyright © 1997 by Electronic Data Systems, Inc.

In the embodiment in which event manager application program 130 is a Tivoli Enterprise Console, information sent by help desk application program 230 to event manager application program 130 preferably matches one of these classes.

Providing information appended to output file 180 and interpreted by logfile adapter 186 regarding the opening or closing of a problem record to event manager application program 130 in a form understandable by event manager application program 130 may be accomplished at step 1040 through the use of rules engine 190. For example, rules engine 190 may update an event in the event manager application program 130 to reflect that a trouble ticket has been requested for the event, update an event in the event manager application program 130 to contain a problem record number associated a problem record, or change the status of an event in the event manager application program.

130 to "CLOSED" when a corresponding problem record number is closed.

In addition, rules engine 190 may drop events. An example of dropping an event is dropping "fake events" sent to event manager application program 130 by trouble ticket script 170. A fake event may be sent by help desk application program 230 to event manager application program 130 as a method for communicating to event manager application program 130 that a trouble ticket has been generated. Such a fake event provides immediate feedback to a monitoring operator who requested generation of a trouble ticket. Once a fake event provides this information, it may be dropped by rules engine 190. A listing of example rules included in an example of rules engine 190 is given below in Table 4.

Thus, through the use of output file 180, logfile adapter 186, and rules engine 190, status information may be provided to event manager application 130 in a format understandable by event manager application program 130. Therefore, according to the invention, status information may be automatically transferred from help desk application program 230 to event manager application program 130 in a format understandable by event manager application program 130.

Details of step 800 of executing trouble ticket script 170 are described in conjunction with FIGURE 2D. Execution of trouble ticket script 170 automatically generates a trouble ticket, which is stand in input file 176, thus facilitating automatic transfer of event information from event manager application program 130 to help desk application program 230.

FIGURE 2D is a flow chart illustrating exemplary steps associated with step 800 of the flow chart shown in FIGURE 2D, illustrating steps associated with executing trouble ticket script 170. A first step of executing trouble ticket script 170 may include step 810 of checking for event acknowledgment. Event acknowledgment may occur, for example, in response to a monitoring operator manually acknowledging an event by clicking an associated menu button on a computer display. Event acknowledgment may occur when automatic generation of a trouble ticket is commanded. As another example, an event may be acknowledged automatically by event manager application program 130 based upon predetermined criteria. If an event is acknowledged, processing may continue. If an event is not acknowledged, processing is halted. In one embodiment an event acknowledgment check is performed by examining the contents of an environment variable storing the status of an event. If the status of an event is "OPEN," then it has not been acknowledged and trouble ticket script 170 is exited. If the status of an event is "ACKNOWLEDGED," then it has been acknowledged.

After an event is acknowledged a check is performed at step 820 for previous generation of a problem record associated with the event. In one embodiment, checking to see if a problem record has been previously generated is accomplished by examining an environment variable associated with event manager application program 130. If no previous problem record was generated, a problem record is opened and event information is written to input file 176 at step 830. Steps associated with one example of writing event information to input file 176 are provided in

an example trouble ticket script listing provided below in Table 3.

At step 840, notification that event information has been written to input file 176 is sent to event manager application program 130. In one embodiment, this notification is addressed to an administrator of event manager application program 130. In another embodiment, a monitoring operator that acknowledged an event for assignment to help desk application program 230 is stored as an environment variable, and notification is sent to that monitoring operator.

At step 850, a fake event is generated. A fake event is generated to update the original event that was received by the event manager application program 130 with an indication that a trouble ticket has been generated for the event. The fake event is sent to event manager application program 130 by using the event handling capabilities of event manager application program 130. The received fake event is then dropped by rules engine 190. An example of sending a fake event to event manager application program 130 is provided in the example trouble ticket listing shown in Table 3.

The above steps 810, 820, 830, 840, and 850 are exemplary steps associated with step 800 of executing trouble ticket script 170, which facilitates automatic transfer of event information from event manager application program 130 to help desk application program 230. Thus, the invention allows for automatic support of computing systems or devices by automatically providing information exchange between an event manager application program and a help desk application program.

Although the invention has been particularly shown and described by the foregoing detailed description, it will be understood by those skilled in the art that various changes in form and detail may be made without departing from the spirit and scope of the invention.

5

Table 3: Example Trouble Ticket Script

```

#!/bin/ksh
#
#
5 # -----
# $Header$
# -----
#
#Copyright © 1997 by Electronic Data Systems, Inc.
10 # This script is used to allow for events viewed through the
# Tivoli Event Console to be used in creating Trouble Tickets
#
# The first and only argument to this shell is the value passed in
# from the Dialog Description language. Using the AEF, the
15 # dialog can be extended to use this shell script to invoke other
# actions by switching on this argument.
#
# The slot values defined for the root class of the T/EC Events
# are set in the environment prior to invoking this shell
20 #
# These environment variables are
#
# ACL, ADAPTER_HOST, ADMINISTRATOR, CAUSE_DATE, CAUSE_HNDL,
# CLASS_NAME, DATE_EVENT, DATE_RECEPTION, EV_KEY,
25 # FORMATTED_DATE,
# HANDLE, HOSTNAME, MSG, ORIGIN, SEVERITY, SOURCE,
# SRVR_HANDLE,
# STATUS, SUB_ORIGIN, and SUB_SOURCE
#
30 # The object ID of the client where the invocation of this shell
# occurred can be obtained from the environment variable TMF_SELF.
#
#####
#
35 # Change Control
#
# Name          Date          Version          Description
# ----          -
#              1.0          Initial Version
40 # E MacDonncha      12/8/96      1.2          - Changes to the
processing of
#
#              $SEVERITY.
#              - Got rid of %customer%,
#              % assignment% and %priority%
45 #              - Got rid of the date
#              blocking.
#####
# Setting up output destination:
# (use alternate output for testing)
50 #####
#
OUT=/opt/sc/tec/tivoli.in

55 #OUT=/tmp/tivoli.in

```

```

#####
# Report generator:
#####

5   TMPFILE=/tmp/TT$$

   gen_file () {
       echo "" > $TMPFILE
       echo "Trouble Ticket $1 for" >> $TMPFILE
10  echo "" >> $TMPFILE
       echo "Class:          ${CLASS_NAME}"           >> $TMPFILE
       echo "Source:         ${SOURCE}"              >> $TMPFILE
       echo "Sub_Source:    ${SUB_SOURCE}"           >> $TMPFILE
       echo "Host:          ${HOSTNAME}"             >> $TMPFILE
15  echo "Origin:          ${ORIGIN}"                >> $TMPFILE
       echo "Sub_Origin:   ${SUB_ORIGIN}"           >> $TMPFILE
       echo "" >> $TMPFILE
       echo "Ev_Key:        ${EV_KEY}"              >> $TMPFILE
       echo "Date:         ${FORMATTED_DATE}"        >> $TMPFILE
20  echo "Severity:       ${SEVERITY}"              >> $TMPFILE
       echo "Status:        ${STATUS}"              >> $TMPFILE
       echo "Administrator: ${ADMINISTRATOR}"       >> $TMPFILE
       echo "" << $TMPFILE
25  echo "Msg:   ${MSG}" >> $TMPFILE
       echo "" >> $TMPFILE
   }

#####
# Event must be acknowledged to raise a trouble ticket.
#####

if [ "${STATUS}" = "OPEN" ]
then
35  exit 1
fi

#####
# If message starts with *, discard TT, is already generated
#####

40  TT_TRUE=${MSG%%\**}

if [ "$TT_TRUE" = "" ] ; then
45  exit 1
fi

#####
# Fixing plogger bug sending \r chars inside $MSG
#####

50  LineMSG=`echo $ {MSG} | awk -F"\n" '{gsub("\r", "|"); printf "%s", $0}'`
#echo "MSG=">/tmp/gt
#echo $MSG>>/tmp/gt

```

```

#echo "lineMSG=">>/tmp/gt
#echo $lineMSG>>/tmp/gt
#####
# Setting up fields used by PNMS
5 # Field for which Tivoli can't provide values are left blank
#####
#
#####
# open or close ticket
10 #####
#
if [ "${STATUS}" = "CLOSED" ] ; then
    evtype=tivpmc
    gen_file closed
15 else
    evtype=tivpmo
    gen_file generated

20 fi

#####
# pass date info in form suitable for PNMS
# it is impossible to use other DATE variables
25 # as they don't have a defined format
#####
#
evtime=`echo $ {FORMATTED_DATE} | awk'
30 BEGIN{
    month["Jan"]="01"
    month["Feb"]="02"
    month["Mar"]="03"
    month["Apr"]="04"
    month["May"]="05"
35 month["Jun"]="06"
    month["Jul"]="07"
    month["Aug"]="08"
    month["Sep"]="09"
    month["Oct"]="10"
40 month["Nov"]="11"
    month["Dec"]="12"
}
# format MM/DD/YY hh:mm:ss
# {print month[$1] "/" $2 "/" substr($4,3) " " $3}
45 {print ""}

# {print month[$1] "/" $2 "/" "11" " " $3}
# {print month[$1] "/" $2 "/" substr($4,3) " " $3}
50 #####
# Determine the TT Category
#####

```

```

#case $ {SUB_SOURCE} in
#  SEC )   category='EDS.NL.SMC.SECURITY';;
#  BCK )   category='EDS.NL.SMC.B/R';;
#  APPL_SC )   category='EDS.NL.SERVICECENTER';;
5 #  * )
#    case ${SOURCE} in
#      HPOV                ) category='EDS.NL.SMC.UNIX';;
#      SVV                  ) category='EDS.NL.SMC.NETWARE';;
#      NT                   ) category='EDS.NL.SMC.NT';;
10 #      LOGFILE | SCRIPT | PATROL ) category='EDS.NL.SMC.UNIX';;
#      *                    ) category='EDS,.NL.SMC.CI';;
#    esac
#esac

15 #
#####
# Split longer lines (longer than 75) into separate lines
#####
#
20 actioni=`echo $ {MSG}|cut -b1-75 -n`
actionii=`echo $ {MSG}|cut -b76- -n`
if [ "${actionii}"="" ]; then
    actioniii="TivoliClass=${CLASS_NAME} "
25 else
    actioniii="TivoliClass=${CLASS_NAME} "
fi

#
30 #####
# change the ADMINISTRATOR variable to first six positions
#####
#
35 SCUSER=`echo $ADMINISTRATOR | awk '{print toupper(substr($1,1,6))}'`

#####
#split the event key into three parts
#####
40 EVSH=`echo $EV_KEY | awk '{print substr($1,1,1)}'`
EVEH=`echo $EV_KEY | awk '{print substr($1,2,1)}'`
EVDATE=`echo $EV_KEY | awk '{print substr($1,3)}'`

45 #####
#setup the other fields
#####
#
evsysseq=
50 evusrseq=${EV_KEY}
evysopt=
evuser=${SCUSER}
evpswd=
evsepchar="^"
55 logical=

```



```

network=${HOSTNAME}
reference=
cause=
networkaddress=
5 type=
domain=
objid=
version=
model=
10 serial=
vendor=
location=
contactname=
contactphone=
15 resolution=
evsh=${EVSH}
eveh=${EVEH}
evdate={EVDATE}
severity=${SEVERITY}
20
#####
# Putting all fields together
#####
#
25
Di="${evtype},${evtime},${evsysseq},${evusrseq},${evsysopt},"
Dii="${evuser},${evpswd},${evsepchar}:${logical}${evsepchar}"
Diii="${network}${evsepchar}${reference}${evsepchar}${cause}"
Div="${evsepchar}${actioni}${evsepchar}${actionii}${evsepchar}"
30 Dv="${actionii}${evsepchar}${networkaddress}${evsepchar}"
Dvi="${type}${evsepchar}${category}${evsepchar}${domain}"
Dvii="${evsepchar}${objid}${evsepchar}${version}${evsepchar}${model}"
Dviii="${evsepchar}${serial}${evsepchar}${vendor}${evsepchar}${locati
on}"
35 Dix="${evsepchar}${contactname}${evsepchar}${contactphone}"
Dx="${evsepchar}${resolution}${evsepchar}${evsh}${evsepchar}"
Dxi="${evsepchar}${evdate}${evsepchar}${severity}"

40 #####
# Appending result to output file
#####
#

echo
45 "${Di}${Dii}${Diii}${Div}${Dv}${Dvi}${Dvii}${Dviii}${Dix}${Dx}${Dxi}"
>>
$OUT

50 #####
# Send reply to Admin
#####

ADMIN="`echo $ADMINISTRATOR | awk -F\@ '{print $1}'`"

55 wsendresp ${ADMIN} $TMPFILE

```

```

#####
# Update the Tivoli Message Slot by sending a fake event
#####

5  wpostmsg -m "Fake Event!!" -rWARNING sub_source=TT\
    ev_server_handle=$SRVR_HANDLE
    ev_date_reception=$DATE_RECEPTION\
    ev_event_handle=$HANDLE SC_Troubleticket SC

10 #####
    # Delete the temporary file we've created ...
    #####

    rm -f $TMPFILE

15  exit

Table 4: Example Rules

20  /* Service Center Rule Set
    * Copyright © 1997 Electronic Data Systems, Inc.
    * Service Center rule set for Service Center events.

    * Author: Fred Kouwenberg
    *
25  * MODIFICATIONS
    */
    /*****
    *****/
30  /***** RULES
    *****/
    /*****
    *****/

35  rule: sc_tt_generated : (

    description: 'Updates the message slot by putting an asterisk in
    front of the message',

40  event: _event of_class 'SC_Troubleticket'
    where [ ev_server_handle: _sh,
    ev_date_reception: _dr,
    ev_event_handle: _eh],

45  reception_action: update_msg_slot: (
    all_instances(event:
    _mod_event of_class 'EVENT'
    where [ server_handle: equals _sh,
    date_reception: equals _dr,
50  event_handle: equals _eh,
    status: equals 'ACK',
    msg: _msg]),
    atomconcat(['*', _msg], _new_msg),
    bo_set_slotval(_mod_event, msg, _new_msg),
55  re_mark_as_modified(_mod_event, _),

```

```

        drop_received_event
    )
).

5  /****/

rule: drop_fake_event: (
10  description: 'Drops the fake event when the old event is already
    gone',
    event: _event of_class 'SC_Troubleticket'
        where [ msg: _msg],
15  reception_action: drop_received_fake_event: (
    atompact(_msg, 'Fake Event', 1, _),
    drop_received_event,
    commit_rule
20  )
).

/****/

25  rule: sc_callnumber_generated : (
    description: 'Updates the sc_callnumber slot with the actual SC
    Callnumber',
30  event: _event of_class 'SC_Callnumber'
    where [ ev_server_handle: _sh,
        ev_date_reception: _dr,
        ev_event_handle: _eh,
        sc_callnumber: _scc],
35  reception_action: update_sc_slot: (
    all_instances(event:
    _mod_event of_class 'EVENT'
    where [ server_handle: equals _sh,
40  date_reception: equals _dr,
        event_handle: equals _eh,
        msg: _msg,
        status: equals 'ACK']),
    atomconcat(['**', _scc ], _new_msg_1),
    atomconcat([_new_msg_1, _msg], _new_msg),
45  re_mark_as_modified(_mod_event,_),
    drop_received_event,
    commit_rule
50  )
).

/****/

55  rule: drop_sc_OPENED_event : (
```

```

description: -'Drops the event that reports that a Service Center
Call is OPENED',

event: _event of_class 'SC_Callnumber'
5   where [ msg: _msg],

reception_action: drop_received_sc_OPENED_event: (
atompарт(_msg, 'OPENED', 1, _),
drop_received_event,
10   commit_rule

)
).

15  /****/

rule: sc_close_event: (

description: 'Closes the Tivoli event when the SC event is closed',
20

event: _event of_class 'SC_Close_Event'
where [ ev_server_handle: _sh,
ev_date_reception: _dr,
ev_event_handle: _eh],

25

reception_action: close_tivoli_event: (
all_instances(event:
_mod_event of_class: 'EVENT'
where [ server_handle: equals _sh,
30   date_reception: equals _dr,
event_handle: equals _eh]),
set_event_status(_mod_event, 'CLOSED'),
re_mark_as_modified(_mod_event, _),
drop_received_event,
35   commit_rule

)
).

40  /****/

rule: drop_sc_CLOSED_event : (

description: 'Drops the event that reports that a Service Center
45   Call is CLOSED',

event: _event of_class 'SC_Close_Event'
where [ msg: _msg],

50

reception_action: drop_received_sc_CLOSED_event: (
atompарт(_msg, 'CLOSED', 1, _),
drop_received_event,
commit_rule

)
55  ).

```

5 /*****
*****/
/***** CHANGE RULES
*****/
/*****
*****/

10 /*****
*****/
/***** TIMER RULES
*****/
/*****
*****/
15

WHAT IS CLAIMED IS:

1. A method for managing a computer system, the method comprising:

5 receiving event information at a Tivoli Enterprise Console, the event information associated with the computer system;

receiving a command to provide a portion of the event information to a help desk application program; and

10 automatically providing the event information in a format readable by a ServiceCenter help desk application program in response to receiving a command to provide a portion of the event information to a help desk applicaion program.

15 2. The method of Claim 1 wherein the step of automatically providing the event information in a format readable by a ServiceCenter help desk application program in response to receiving a command to provide a portion of the event information to a help desk application program

20 further comprises the step of automatically providing the event information to a ServiceCenter help desk application program.

25 3. The method of Claim 1 wherein the step of automatically providing the event information in a format readable by a ServiceCenter help desk application program comprises automatically generating a trouble ticket.

4. The method of Claim 3 and further comprising the steps of:

generating an identification number associated with the automatic generation of a trouble ticket; and

5 automatically providing the identification number to the Tivoli Enterprise Console.

5. The method of Claim 1 and further comprising the steps of:

10 determining whether a problem record has been generated in response to the step of providing the event information in a format readable by a ServiceCenter help desk application program; and

15 opening a problem record if a problem record has not been generated in response to the step of automatically providing the event information in a format readable by a ServiceCenter help desk application program.

6. The method of Claim 1 wherein the step of receiving a command to provide a portion of the event information to a help desk application program comprises receiving a command automatically generated based on the content of the event information.

25 7. The method of Claim 1 and further comprising the steps of:

opening a problem record in response to automatically providing the event information in a format readable by a ServiceCenter help desk application program;

30 processing the problem record; and

automatically providing status information associated with processing the problem record to the Tivoli Enterprise Console.

- 5 8. The method of Claim 7 wherein the step of automatically providing status information comprises the steps of:
- monitoring an output file for added information;
 - detecting added information in the output file; and
 - 10 translating the added information into a format understandable by a Tivoli Enterprise Console.
9. A management system for managing a monitored device, the management system comprising:
- 15 a computing system comprising at least one processor and at least one memory accessible by the at least one processor;
 - a Tivoli Enterprise Console event management system stored in the computing system, the event management system
 - 20 operable to receive and process an event having event information, the event associated with the monitored device;
 - a ServiceCenter help desk application program stored in the computing system, the help desk application program
 - 25 operable to process a problem record; and
 - interface programming stored on the computing system operable to automatically provide the event information associated with the event to the help desk application program in a format readable by the help desk application
 - 30 program.

10. The management system of Claim 9 wherein:

the ServiceCenter help desk application program is further operable to generate an identification number associated with the event; and

5 the interface programming is further operable provide the identification number to the event management system.

11. The system of Claim 9 wherein the interface programming is further operable to:

10 determine if an identification number associated with the event has been generated; and

generate an identification number associated with the event if an identification number associated with the event has not been generated.

15

12. The system of Claim 9 wherein the interface programming is operable to monitor an input file for changes and in response to detecting changes transmit information contained in the file to the ServiceCenter help desk application program.

20

13. The system of Claim 9 wherein the interface programming is operable to provide status information associated with the problem record in a format understandable by the Tivoli Enterprise Console.

25

14. A systems management system, the system comprising:

a computing system comprising at least one processor and at least one memory accessible by the at least one processor;

30

a Tivoli Enterprise Console stored in the computing system and operable to run on the computing system, the Tivoli Enterprise Console operable to receive and process an event, the event containing event information;

5 a ServiceCenter help desk application stored in computing system and operable to run on the computing system, the ServiceCenter help desk operable to process a trouble ticket; and

10 interface programming stored on the computing system operable to automatically generate a trouble ticket based on the event information.

15 15. The computerized system of Claim 14 wherein the interface programming further comprises programming operable to determine if a trouble ticket has previously been generated for the event.

20 16. The computerized system of Claim 14 wherein the interface programming further comprises programming operable to send a fake Tivoli event to the ServiceCenter, the fake Tivoli event indicating that a trouble ticket has been requested for the event.

25 17. The computerized system of Claim 14 wherein the interface programming further comprises programming operable to receive information in response to the ServiceCenter processing a trouble ticket and provide an identification number associated with the trouble ticket to the Tivoli Enterprise Console.

30

18. The computerized system of Claim 14 wherein the interface programming further comprises programming operable to monitor an output file for changes and in response to detecting changes in the output file provide
5 information associated with the trouble ticket to the Tivoli Enterprise Console in a format understandable by the Tivoli Enterprise Console.

19. The computerized system of Claim 14 wherein the
10 interface programming further comprises programming operable to monitor an input file for changes to the input file and upon detecting changes to the input file transmit information contained in the input file to a portion of the ServiceCenter help desk application in a format
15 understandable by the ServiceCenter help desk application.

20. The computerized system of Claim 14 wherein the interface programming further comprises an AXFILED process and the interface programming further comprises an
20 executable file operable to generate an input file based on the event information, the input file having a format the can be read by the ServiceCenter AXFILED process.

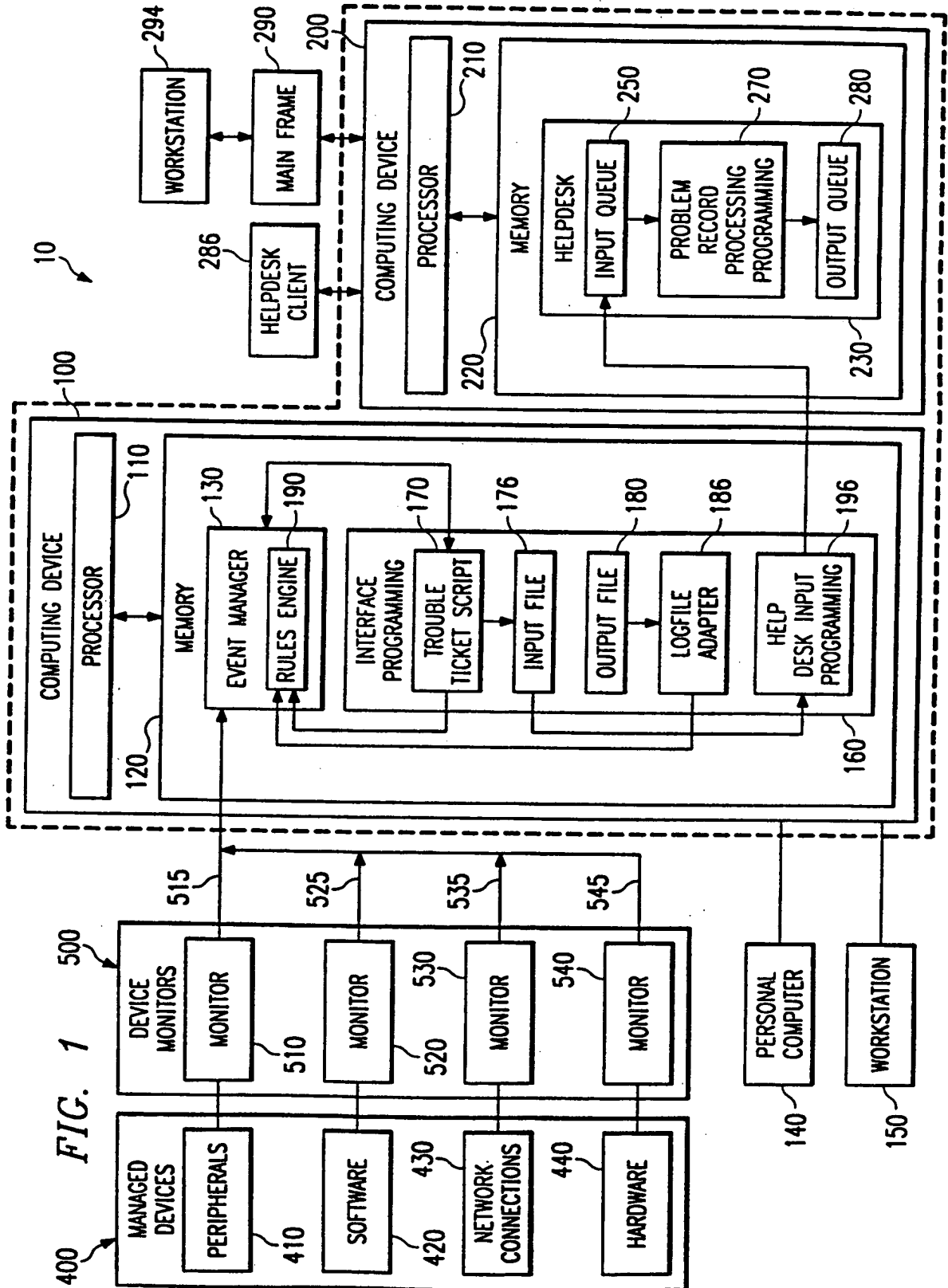

FIG. 1

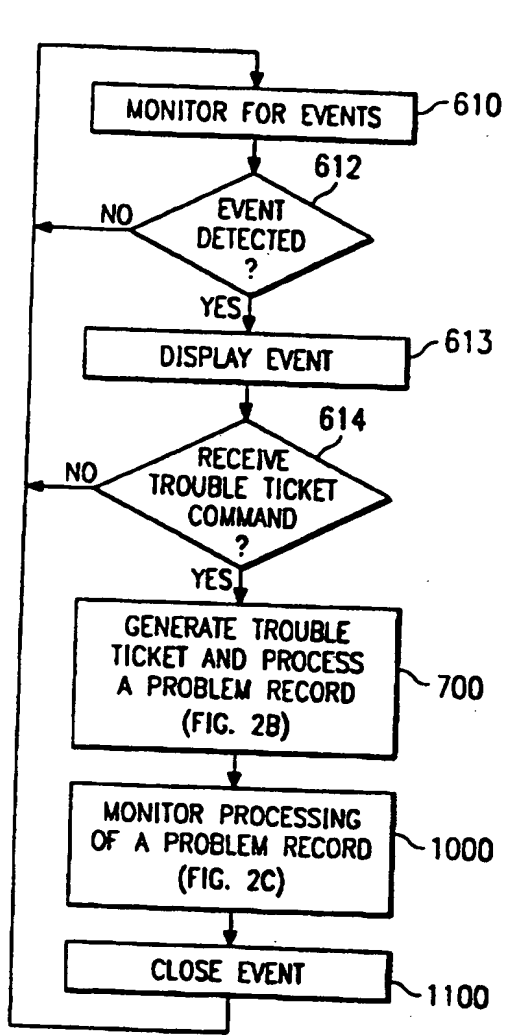

FIG. 2A

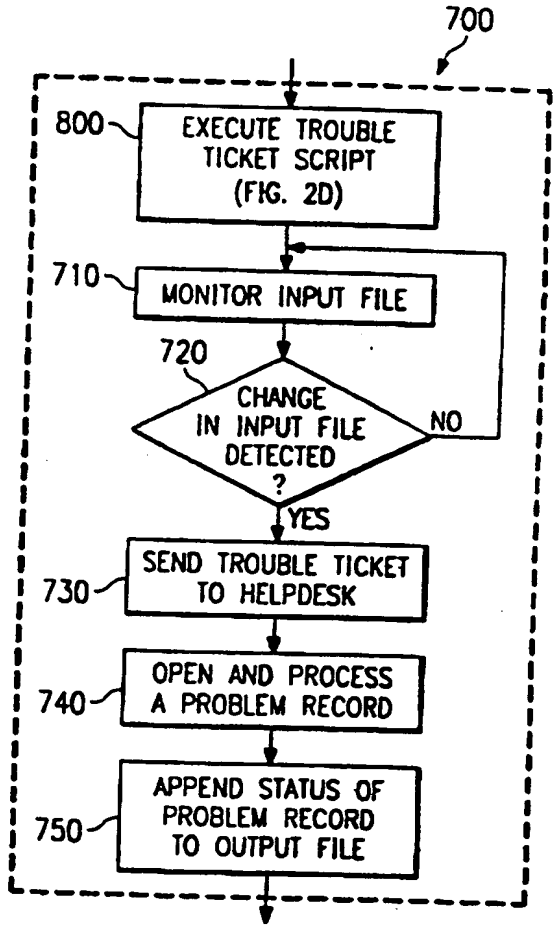

FIG. 2B

FIG. 2C

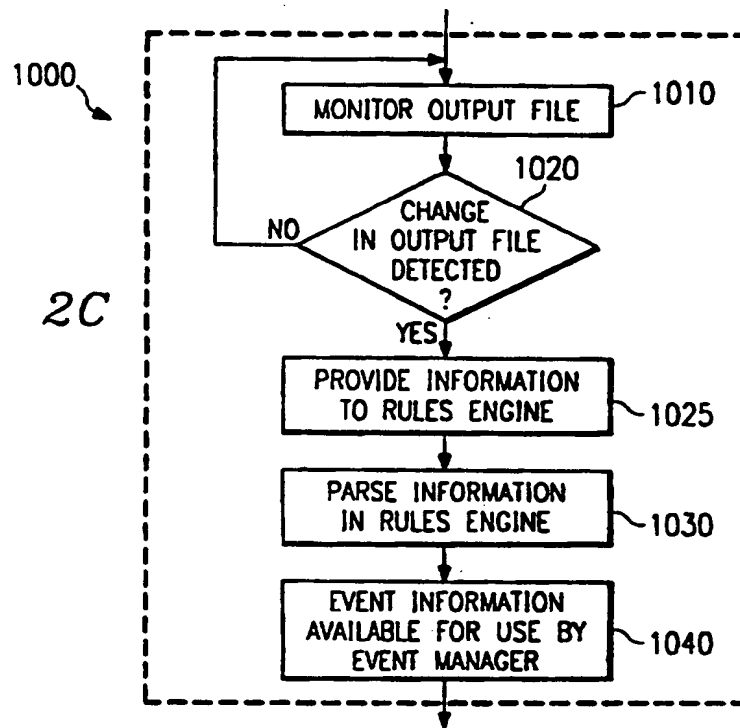
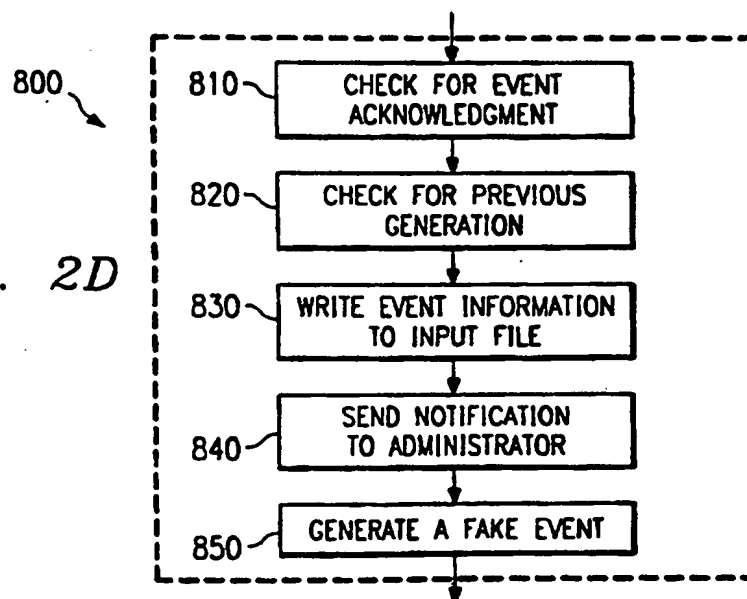

FIG. 2D



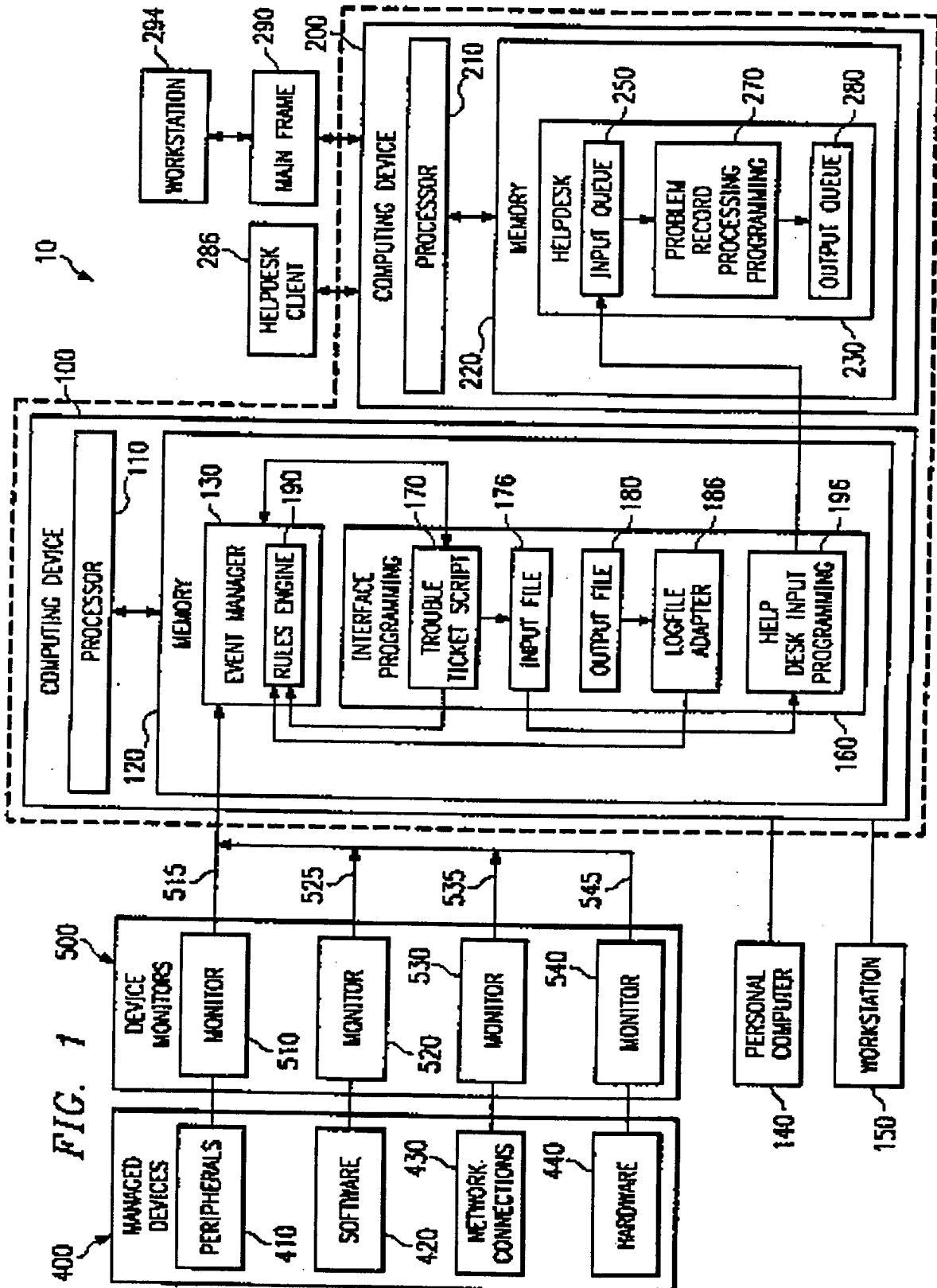

FIG. 1

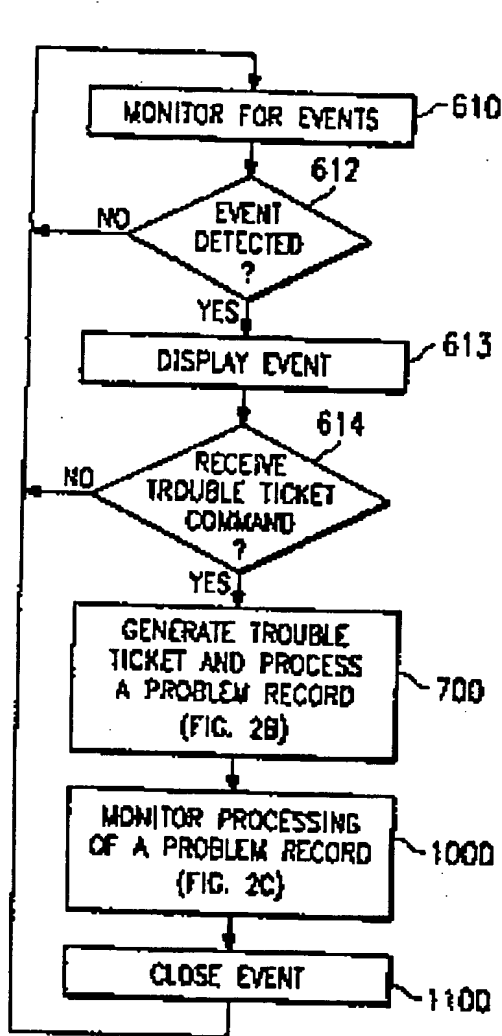

FIG. 2A

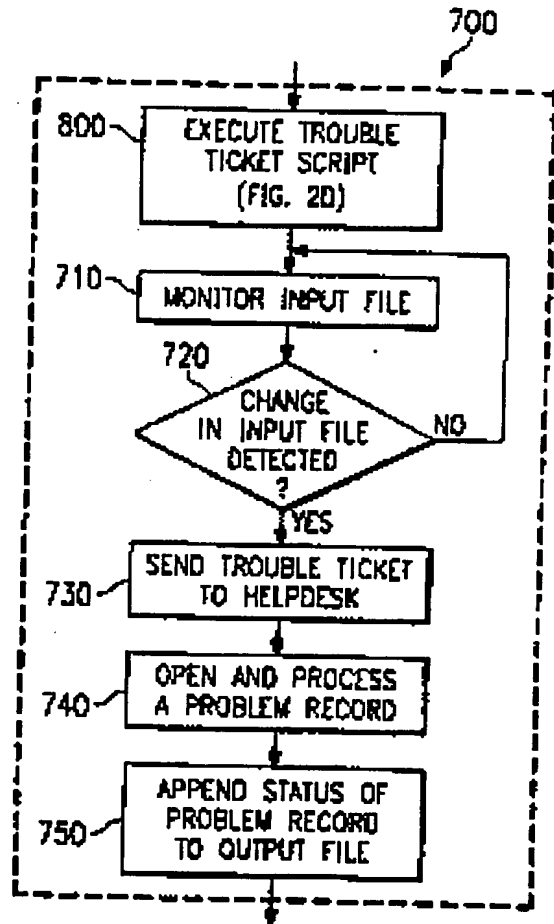

FIG. 2B



INTERNATIONAL APPLICATION PUBLISHED UNDER THE PATENT COOPERATION TREATY (PCT)

<p>(51) International Patent Classification ⁶ : H04L 12/24, G06F 11/32</p>	<p>A3</p>	<p>(11) International Publication Number: WO 98/52121 (43) International Publication Date: 19 November 1998 (19.11.98)</p>
<p>(21) International Application Number: PCT/US98/09837 (22) International Filing Date: 13 May 1998 (13.05.98) (30) Priority Data: 08/855,081 13 May 1997 (13.05.97) US (71) Applicant: ELECTRONIC DATA SYSTEMS CORPORATION [US/US]; 5400 Legacy Drive, M/S H3-3A-05, Plano, TX 75024 (US). (72) Inventors: TOPFF, Guido, E., J.; Putrand 4, B-2288 Grobbendonk (BE). KOUWENBERG, Frederik, P., J.; Loevestein 38, NL-2804 EV Gouda (NL). (74) Agent: GRIEBENOW, L., Joy; Electronic Data Systems Corporation, 5400 Legacy Drive, H3-3A-05, Plano, TX 75024 (US).</p>	<p>(81) Designated States: European patent (AT, BE, CH, CY, DE, DK, ES, FI, FR, GB, GR, IE, IT, LU, MC, NL, PT, SE). Published <i>With international search report.</i> (88) Date of publication of the international search report: 18 February 1999 (18.02.99)</p>	

(54) Title: METHOD AND SYSTEM FOR MANAGING COMPUTER SYSTEMS

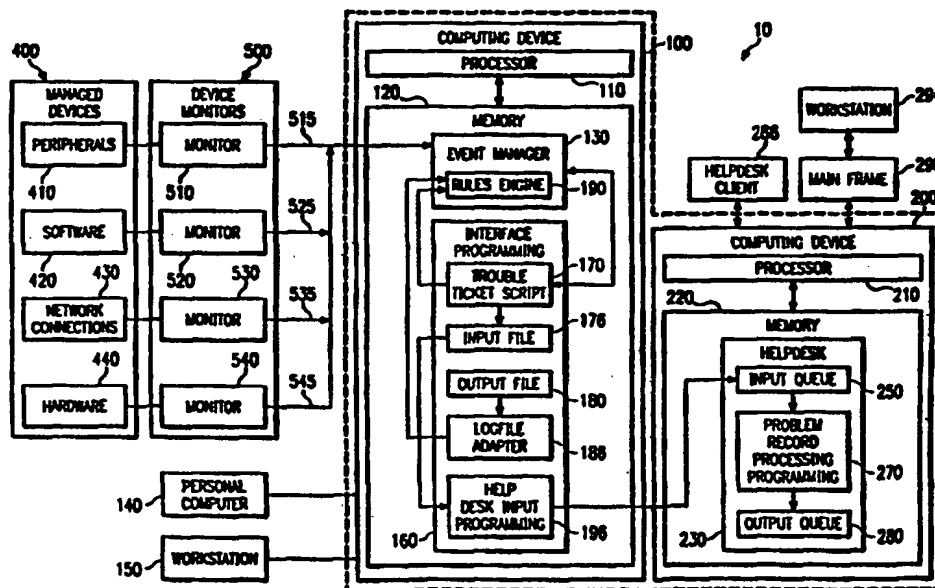

(57) Abstract

According to one aspect of the invention, a method of managing a computer system includes receiving event information at a Tivoli Enterprise Console (130), the event information associated with the computer system. The method also includes receiving a command to provide a portion of the event information to a help desk application program and automatically providing the event information in a format readable by a ServiceCenter help desk application program (230) in response to receiving a command to provide a portion of the event

FOR THE PURPOSES OF INFORMATION ONLY

Codes used to identify States party to the PCT on the front pages of pamphlets publishing international applications under the PCT.

AL	Albania	ES	Spain	LS	Lesotho	SI	Slovenia
AM	Armenia	FI	Finland	LT	Lithuania	SK	Slovakia
AT	Austria	FR	France	LU	Luxembourg	SN	Senegal
AU	Australia	GA	Gabon	LV	Latvia	SZ	Swaziland
AZ	Azerbaijan	GB	United Kingdom	MC	Monaco	TD	Chad
BA	Bosnia and Herzegovina	GE	Georgia	MD	Republic of Moldova	TG	Togo
BB	Barbados	GH	Ghana	MG	Madagascar	TJ	Tajikistan
BE	Belgium	GN	Guinea	MK	The former Yugoslav Republic of Macedonia	TM	Turkmenistan
BF	Burkina Faso	GR	Greece			TR	Turkey
BG	Bulgaria	HU	Hungary	ML	Mali	TT	Trinidad and Tobago
BJ	Benin	IE	Ireland	MN	Mongolia	UA	Ukraine
BR	Brazil	IL	Israel	MR	Mauritania	UG	Uganda
BY	Belarus	IS	Iceland	MW	Malawi	US	United States of America
CA	Canada	IT	Italy	MX	Mexico	UZ	Uzbekistan
CF	Central African Republic	JP	Japan	NE	Niger	VN	Viet Nam
CG	Congo	KE	Kenya	NL	Netherlands	YU	Yugoslavia
CH	Switzerland	KG	Kyrgyzstan	NO	Norway	ZW	Zimbabwe
CI	Côte d'Ivoire	KP	Democratic People's Republic of Korea	NZ	New Zealand		
CM	Cameroon			PL	Poland		
CN	China	KR	Republic of Korea	PT	Portugal		
CU	Cuba	KZ	Kazakstan	RO	Romania		
CZ	Czech Republic	LC	Saint Lucia	RU	Russian Federation		
DE	Germany	LI	Liechtenstein	SD	Sudan		
DK	Denmark	LK	Sri Lanka	SE	Sweden		
EE	Estonia	LR	Liberia	SG	Singapore		

INTERNATIONAL SEARCH REPORT

International Application No

PCT/US 98/09837

A. CLASSIFICATION OF SUBJECT MATTER
 IPC 6 H04L12/24 G06F11/32

According to International Patent Classification (IPC) or to both national classification and IPC

B. FIELDS SEARCHED

Minimum documentation searched (classification system followed by classification symbols)

IPC 6 H04L G06F

Documentation searched other than minimum documentation to the extent that such documents are included in the fields searched

Electronic data base consulted during the international search (name of data base and, where practical, search terms used)

C. DOCUMENTS CONSIDERED TO BE RELEVANT

Category	Citation of document, with indication, where appropriate, of the relevant passages	Relevant to claim No.
A	EP 0 295 426 A (IBM) 21 December 1988 see abstract see column 1, line 1-20 see column 4, line 10 - column 6, line 50 see figure 1B ---	1, 9, 14
A	JANDER M: "MANAGEMENT FRAMEWORKS MOVING TOWARD A UNIFIED VIEW OF DISTRIBUTED NETWORKS" DATA COMMUNICATIONS, vol. 23, no. 3, 1 February 1994, pages 58-66, 68, XP000422746 see page 58, left-hand column, paragraph 1 - right-hand column, paragraph 2 see page 59, right-hand column, paragraph 5 - page 62, left-hand column, paragraph 2 see page 64, left-hand column, paragraph 2 - page 68, middle column, paragraph 5 --- -/--	1, 9, 14

Further documents are listed in the continuation of box C.

Patent family members are listed in annex.

* Special categories of cited documents :

- "A" document defining the general state of the art which is not considered to be of particular relevance
- "E" earlier document but published on or after the international filing date
- "L" document which may throw doubts on priority claim(s) or which is cited to establish the publication date of another citation or other special reason (as specified)
- "O" document referring to an oral disclosure, use, exhibition or other means
- "P" document published prior to the international filing date but later than the priority date claimed

- "T" later document published after the international filing date or priority date and not in conflict with the application but cited to understand the principle or theory underlying the invention
- "X" document of particular relevance; the claimed invention cannot be considered novel or cannot be considered to involve an inventive step when the document is taken alone
- "Y" document of particular relevance; the claimed invention cannot be considered to involve an inventive step when the document is combined with one or more other such documents, such combination being obvious to a person skilled in the art.
- "&" document member of the same patent family

Date of the actual completion of the international search

28 October 1998

Date of mailing of the international search report

04/11/1998

Name and mailing address of the ISA

European Patent Office, P.B. 5818 Patentlaan 2
 NL - 2280 HV Rijswijk
 Tel. (+31-70) 340-2040, Tx. 31 651 epo nl,
 Fax (+31-70) 340-2040

Authorized officer

Llorens V

C.(Continuation) DOCUMENTS CONSIDERED TO BE RELEVANT		
Category	Citation of document, with indication, where appropriate, of the relevant passages	Relevant to claim No.
A	WO 96 31035 A (CABLETRON SYSTEMS INC) 3 October 1996 see abstract see page 1, line 13 - page 3, line 7 see page 5, line 20 - page 6, line 13 see figure 2 -----	1,9,14

FIG. 2C

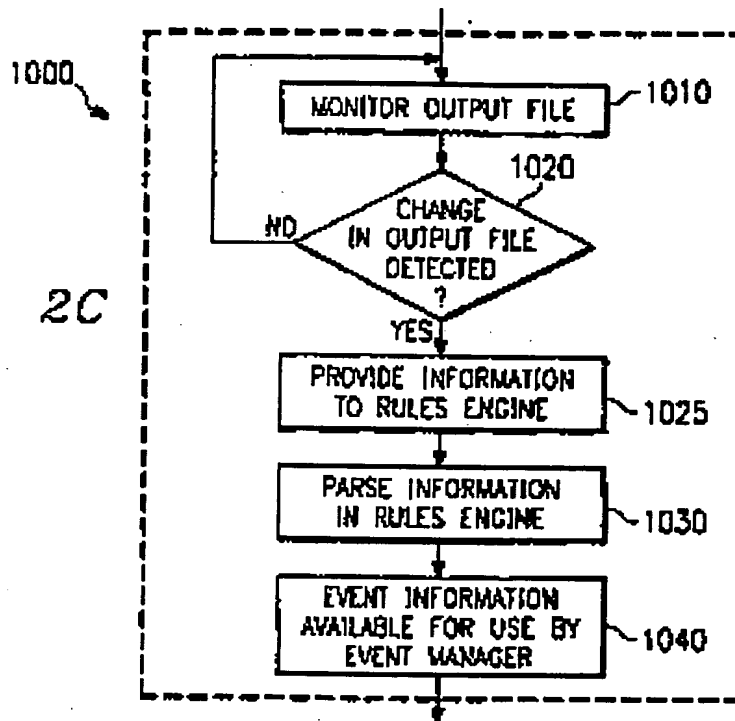

FIG. 2D

